



# OD2-N120W60C2

OD Value

DISPLACEMENT MEASUREMENT SENSORS

**SICK**  
Sensor Intelligence.



### Ordering information

Type	Part no.
OD2-N120W60C2	6036619

Other models and accessories → [www.sick.com/OD\\_Value](http://www.sick.com/OD_Value)



### Detailed technical data

#### Performance

<b>Measuring range</b>	60 mm ... 180 mm, 6 % ... 90 % remission
<b>Resolution</b>	30 µm <sup>1)</sup>
<b>Repeatability</b>	90 µm <sup>2) 1) 3) 4)</sup>
<b>Linearity</b>	± 120 µm <sup>1) 5) 4) 6)</sup>
<b>Response time</b>	1 ms / 10 ms / 35 ms <sup>7)</sup>
<b>Measuring frequency</b>	2 kHz
<b>Light source</b>	Laser, red
<b>Laser class</b>	2 (EN 60825-1) <sup>8)</sup>
<b>Typ. light spot size (distance)</b>	1 mm x 1.5 mm (120 mm)
<b>Additional function</b>	Mean-value setting 1 ... 64x, automatic sensitivity adjustment, Teach-in of switching output, Invertible switching output, multifunctional input: laser-off / external teach-in / trigger, switching mode: distance to object (DtO), switching mode: window (Wnd)

<sup>1)</sup> At averaging function medium.

<sup>2)</sup> 6 % ... 90 % remission.

<sup>3)</sup> Constant ambient conditions.

<sup>4)</sup> For best performance consider warm up time ≤ 5 minutes.

<sup>5)</sup> Measurement on 90 % remission (ceramic, white)

<sup>6)</sup> When calibrated in the application regularly.

<sup>7)</sup> Automatic sensitivity adjustment ≤ 4 ms, 6 ms for the models with measuring range of 100 mm ... 400 mm.

<sup>8)</sup> Wavelength: 655 nm, max. output: 1 mW.

#### Interfaces

<b>Switching output</b>	2 x NPN (100 mA) <sup>1)</sup>
<b>Multifunctional input (MF)</b>	1 x MF <sup>2)</sup>

<sup>1)</sup> PNP: HIGH = V<sub>S</sub> - (< 2 V) / LOW = < 2 V; NPN: HIGH = < 2 V / LOW = V<sub>S</sub>.

<sup>2)</sup> MF can be used as laser-off, trigger, external teach-in, or deactivated; response time ≤ 3 ms.

Mechanics/electronics

<b>Supply voltage <math>V_s</math></b>	DC 12 V ... 24 V <sup>1)</sup>
<b>Power consumption</b>	$\leq 2.88$ W <sup>2)</sup>
<b>Warm-up time</b>	$\leq 30$ min
<b>Housing material</b>	PBT housing with PMMA lens
<b>Connection type</b>	Cable, 2 m
<b>Indication</b>	Distance bar graph, up to 8 status LEDs
<b>Weight</b>	70 g

<sup>1)</sup> DC 12 V (-5 %) ... 24 V (+10 %); DC 18 V (-5 %) ... DC 24 V (+10 %) when using analog voltage output.

<sup>2)</sup> Without load, with current output.

Ambient data

<b>Enclosure rating</b>	IP 67
<b>Protection class</b>	III
<b>Ambient temperature</b>	Operation: -10 °C ... +40 °C Storage: -20 °C ... +60 °C
<b>Relative air humidity (non-condensing)</b>	35 % ... 95 %
<b>Temperature drift</b>	$\pm 0.08$ % FS/K (FS = Full Scale = Measuring range of sensor)
<b>Typ. Ambient light immunity</b>	Artificial light: $\leq 3,000$ lx Sunlight: $\leq 10,000$ lx
<b>Vibration resistance</b>	10 Hz ... 55 Hz (amplitude 1.5 mm, x-, y-, z-axis 2 hours each)
<b>Shock resistance</b>	50 G (x, y, z axis 3 times each)

Dimensional drawing (Dimensions in mm (inch))

OD2-x120W60xx

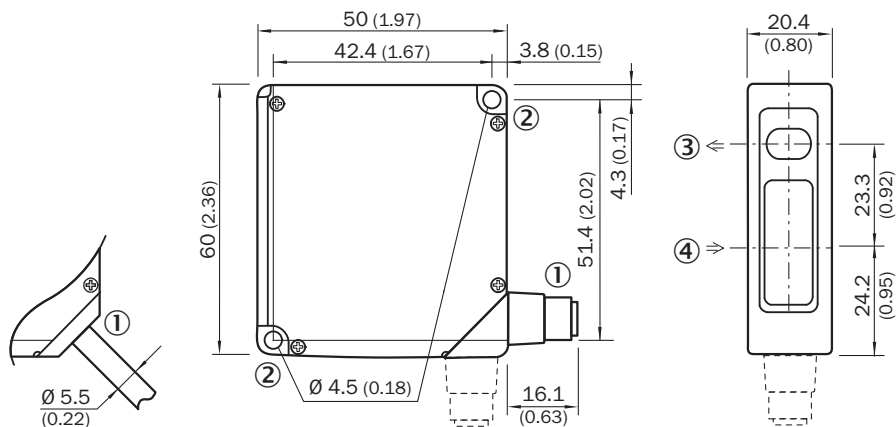

- ① 2 m cable or M12 connector; 90° rotatable
- ② Mounting hole,  $\varnothing 4.5$  mm
- ③ Optical axis sender
- ④ Optical axis receiver

### Connection type

OD2-xxxxxA2 OD2-xxxxxC2 OD2-xxxxxI2 OD2-xxxxxU2 cable

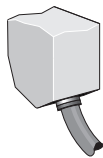

### Connection diagram

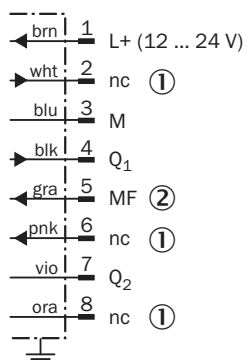

- ① Not assigned
- ② Multifunctional input (MF)

### Adjustment possible

OD2-xxxxxCx

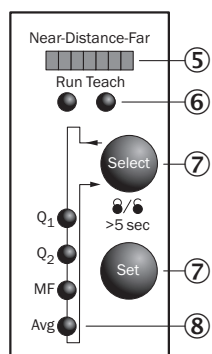

- ⑤ Distance indicator
- ⑥ Mode indicator (Run/Teach)
- ⑦ Operating elements
- ⑧ Status indicator in- and outputs (Run-mode)/menu indicator (Teach-mode)

## Light spot size

OD2-x120W60xx

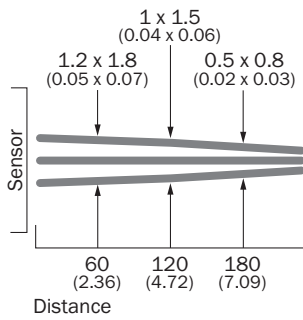

All dimensions in mm (inch)

## Linearity

OD2-x120xxxxx

Linearity [%FS]

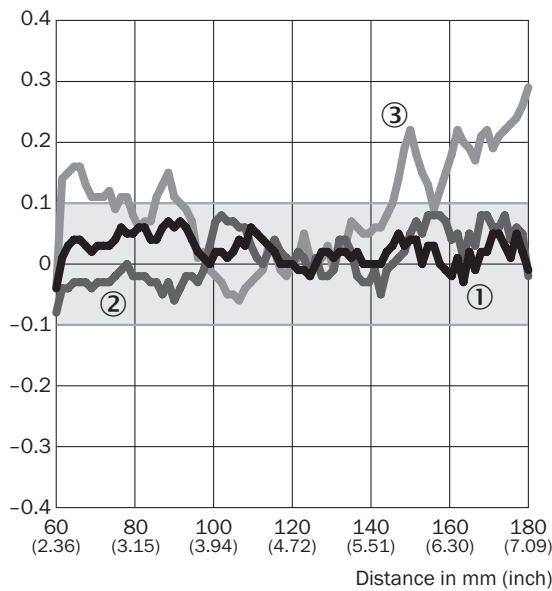

- ① White ceramic
- ② Black paper
- ③ Stainless steel

## Recommended accessories

Other models and accessories → [www.sick.com/OD\\_Value](http://www.sick.com/OD_Value)

	Brief description	Type	Part no.
	Plug connectors and cables		

	Brief description	Type	Part no.
	Head A: female connector, M12, 8-pin, straight Head B: cable Cable: special color code, PVC, shielded, 2 m	DOL-1208-G02MF	6020663
	Head A: female connector, M12, 8-pin, straight Head B: cable Cable: special color code, PVC, shielded, 5 m	DOL-1208-G05MF	6020664
	Head A: female connector, M12, 8-pin, straight Head B: cable Cable: special color code, PVC, shielded, 10 m	DOL-1208-G10MF	6048434

## SICK AT A GLANCE

SICK is one of the leading manufacturers of intelligent sensors and sensor solutions for industrial applications. A unique range of products and services creates the perfect basis for controlling processes securely and efficiently, protecting individuals from accidents and preventing damage to the environment.

We have extensive experience in a wide range of industries and understand their processes and requirements. With intelligent sensors, we can deliver exactly what our customers need. In application centers in Europe, Asia and North America, system solutions are tested and optimized in accordance with customer specifications. All this makes us a reliable supplier and development partner.

Comprehensive services complete our offering: SICK LifeTime Services provide support throughout the machine life cycle and ensure safety and productivity.

For us, that is “Sensor Intelligence.”

## WORLDWIDE PRESENCE:

Contacts and other locations –[www.sick.com](http://www.sick.com)